

DRAWING NO.  
AL 77027C6

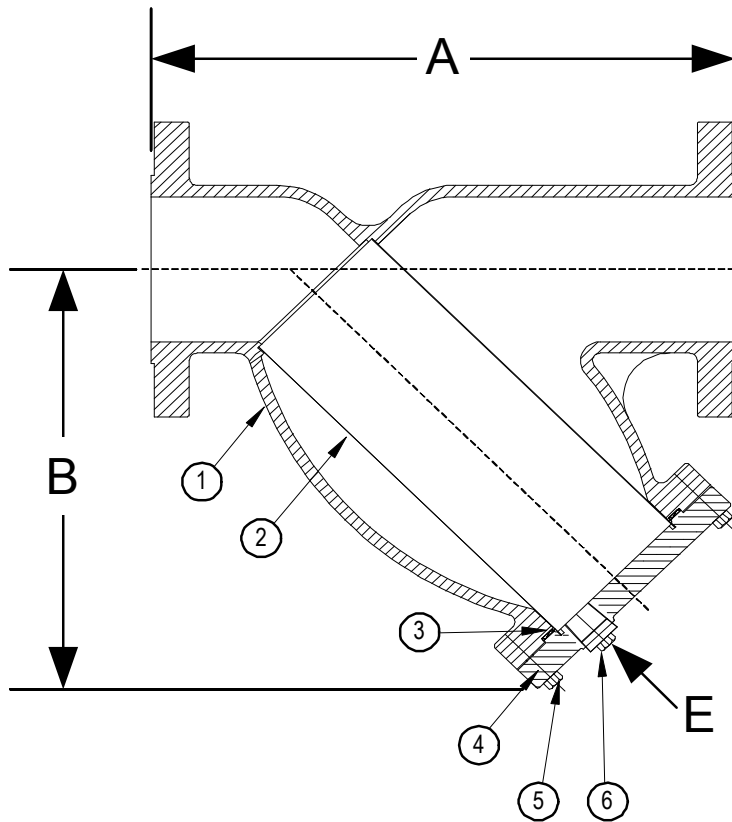

BODY PRESSURE & TEMPERATURE RATINGS - NON SHOCK		
NOM. RATING	MEDIA	1/2" to 14"
300# R.F.& D. (EX. HEAVY FLANGE)	STEAM	300 PSI @ 1125°F
	W.O.G.	720 PSI @ 100°F

PARTS LIST		
ITEM	DESCRIPTION	MATERIAL
1	BODY	CAST CHROME-MOLY (ASTM A 217, GRADE WC6)
2	SCREEN	STAINLESS STEEL (304)
3	GASKET	SPIRAL WOUND STAINLESS STEEL (304) - WITH GRAPHITE FILLER
4	COVER	CAST CHROME-MOLY (ASTM A 217, GRADE WC6)
5	HEX HEAD CAP SCREWS	STAINLESS STEEL (ASTM A 193, GRADE B8)
6	BLOW-OFF PLUG	STAINLESS STEEL (304)

Product Number†	SIZE	DIMENSIONS (in)			COVER		WEIGHT (lbs)
		A	B	E	No. of Bolts	Size of Bolts	
1/24RFY-C6045P34-GB	1/2	6-1/8	3-3/4	3/8	4	3/8-16 x 1-1/2	6
3/44RFY-C6045P34-GB	3/4	7-3/4	4-1/4	1/2	4	3/8-16 x 1-1/2	13
14RFY-C6045P34-GB	1	7-7/8	4-1/4	1/2	4	3/8-16 x 1-1/2	13
11/44RFY-C6045P34-GB	1-1/4	8-1/8	5-1/8	1/2	4	3/8-16 x 1-1/2	19
11/24RFY-C6045P34-GB	1-1/2	8-1/4	5-1/8	1/2	4	3/8-16 x 1-1/2	19
24RFY-C6045P34-GB	2	9-1/2	6	1/2	4	1/2-13 x 1-3/4	33
21/24RFY-C6045P34-GB	2-1/2	10-3/8	7	1	4	1/2-13 x 1-3/4	44
34RFY-C6045P34-GB	3	12	7-5/16	1	4	1/2-13 x 1-3/4	58
44RFY-C6045P34-GB	4	14-1/2	8-15/16	1-1/2	6	1/2-13 x 1-3/4	90
54RFY-C6045P34-GB	5	19-5/16	13-1/32	2	12	5/8-11 x 2-1/4	180
64RFY-C6045P34-GB	6	19-5/16	13-1/4	2	12	5/8-11 x 2-1/4	180
84RFY-C6045P34-GB	8	23-3/8	15-1/2	2	12	5/8-11 x 2-3/4	304
104RFY-C6045P34-GB	10	27-3/8	18-7/16	2	16	5/8-11 x 3	470
124RFY-C6062P34-GB	12	32	21-5/8	2	20	5/8-11 x 3-1/4	709
144RFY-C6062P34-GB	14	36	25	2	16	3/4-10 x 3-1/8	1300

†See "Style SSA-7 Product Number Configuration" for additional options.

STANDARD SCREENS SUPPLIED

SIZE in	SCREEN GAGE	SCREEN PERFORATION			
		FOR STEAM in	OPEN AREA	FOR LIQUID in	OPEN AREA
1/2 to 4	28	3/64	33%	1/16	30%
5 to 10	24	3/64	33%	1/8	43%
12 to 14	24	1/16	30%	1/8	43%

Standard screens supplied are for **steam service**, unless otherwise specified.  
Options: Other perforations, meshes, and screen materials are available.

**KECKLEY**

3400 CLEVELAND SKOKIE ILLINOIS

DRAWING NO.  
AL 77027C6

DIMENSIONAL ASSEMBLY

PART NO.

1/2" to 14" 300# Flg Style SA-7C6

SCALE: NTS

DATE: 07/01/2011

MAT'L: Cast Chrome-Moly WC6

REQ. ---

DR. BY DSF