

DRAWING NO.
AL 90300C9

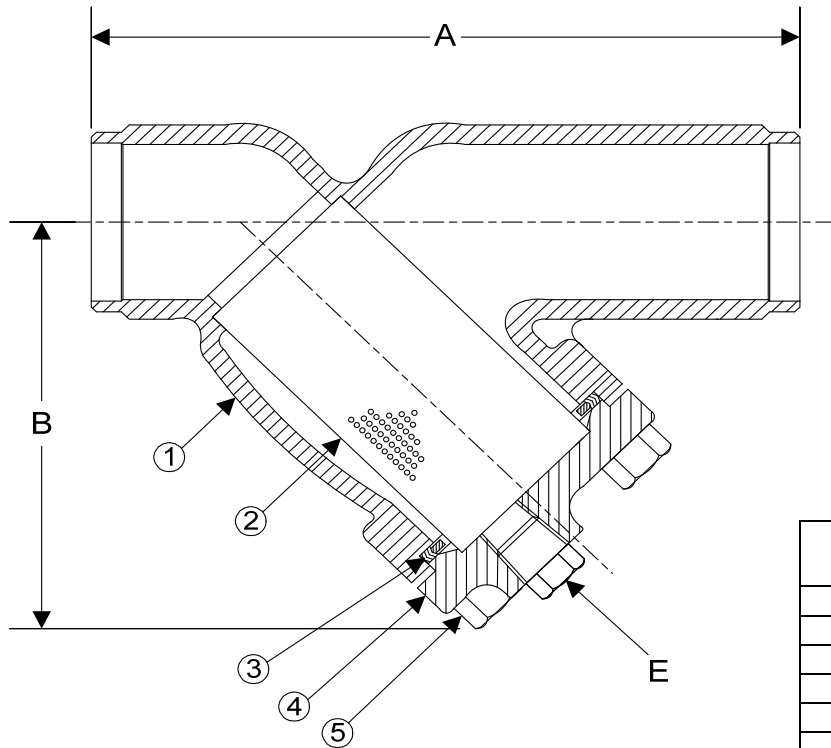

BODY PRESSURE & TEMPERATURE RATINGS - NON SHOCK		
NOM. RATING	MEDIA	1/2" to 14"
150# BUTT WELD	STEAM	150 PSI @ 565°F
	W.O.G.	275 PSI @ 100°F

PARTS LIST		
ITEM	DESCRIPTION	MATERIAL
1	BODY	CAST CHROME-MOLY (ASTM A 217, GRADE WC9)
2	SCREEN	STAINLESS STEEL (304)
3	GASKET	SPIRAL WOUND STAINLESS STEEL (304) - WITH GRAPHITE FILLER
4	COVER	CAST CHROME-MOLY (ASTM A 217, GRADE WC9)
5	HEX HEAD CAP SCREWS	STAINLESS STEEL (ASTM A 193, GRADE B8)

Optional: Blow-off Plug, Stainless Steel (304)

Product Number†	SIZE	DIMENSIONS (in)			COVER		WEIGHT (lbs)
		A	B	E	No. of Bolts	Size of Bolts	
1/22B4Y-C9045P34-GB	1/2	6-1/2	3-3/4	3/8	4	3/8-16 x 1-1/2	7
3/42B4Y-C9045P34-GB	3/4	7-3/8	4-1/4	1/2	4	3/8-16 x 1-1/2	11
12B4Y-C9045P34-GB	1	7-3/8	4-1/4	1/2	4	3/8-16 x 1-1/2	11
11/42B4Y-C9045P34-GB	1-1/4	7	5-1/8	1/2	4	3/8-16 x 1-1/2	12
11/22B4Y-C9045P34-GB	1-1/2	7-1/8	5-1/8	1/2	4	3/8-16 x 1-1/2	14
22B4Y-C9045P34-GB	2	7-7/8	6	1/2	4	1/2-13 x 1-3/4	22
21/22B4Y-C9045P34-GB	2-1/2	9-3/4	7	1	4	1/2-13 x 1-3/4	32
32B4Y-C9045P34-GB	3	10-1/16	7-7/16	1	4	1/2-13 x 1-3/4	41
42B4Y-C9045P34-GB	4	12-1/8	8-15/16	1-1/2	4	1/2-13 x 1-3/4	63
52B4Y-C9045P34-GB	5	15-1/2	13-1/32	2	8	5/8-11 x 2-1/4	111
62B4Y-C9045P34-GB	6	18-1/2	13-1/4	2	8	5/8-11 x 2-1/4	136
82B4Y-C9045P34-GB	8	21-3/8	15-1/2	2	12	5/8-11 x 2-1/4	212
102B4Y-C9045P34-GB	10	26	18-7/16	2	12	5/8-11 x 2-1/4	280
122B4Y-C9062P34-GB	12	29-7/8	21-5/8	2	16	5/8-11 x 2-3/4	460

†See "Style SSA-7 Product Number Configuration" for additional options.

STANDARD SCREENS SUPPLIED

SIZE in	SCREEN GAGE	SCREEN PERFORATION			
		FOR STEAM in	OPEN AREA	FOR LIQUID in	OPEN AREA
1/2 to 4	28	3/64	33%	1/16	30%
5 to 10	24	3/64	33%	1/8	43%
12 to 14	24	1/16	30%	1/8	43%

Standard screens supplied are for **steam service**, unless otherwise specified.
Options: Other perforations, meshes, and screen materials are available.

KECKLEY

3400 CLEVELAND SKOKIE ILLINOIS

DRAWING NO.
AL 90300C9

DIMENSIONAL ASSEMBLY

PART NO.

1/2" to 12" 150# Schd 40 Butt Weld

SCALE: NTS

Style SA-7C9

DATE: 07/01/2011

MAT'L: Cast Chrome-Moly WC9

REQ. ---

DR. BY DSF