

DRAWING NO.
AL 77015C9

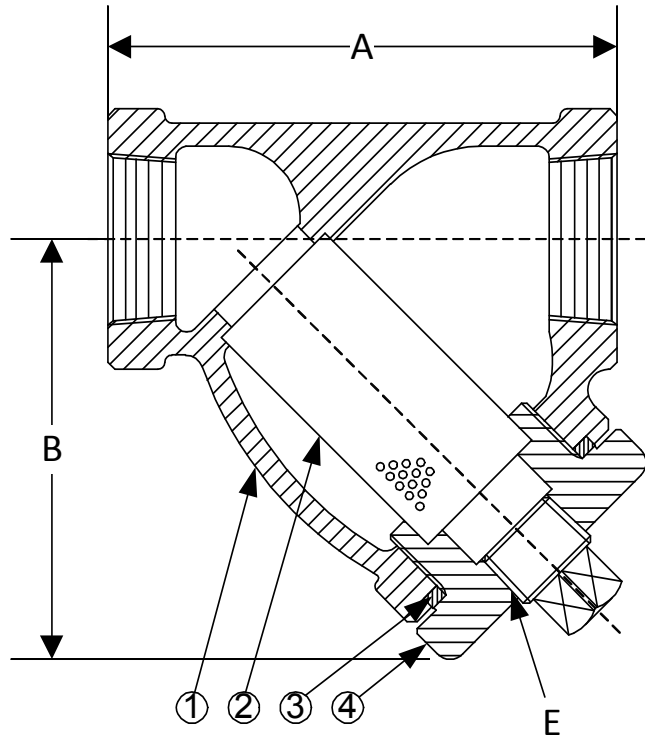

BODY PRESSURE & TEMPERATURE RATINGS – NON SHOCK		
NOM. RATING	MEDIA	1/4" to 3"
600# (THREADED)	STEAM	600 PSI @ 1125°F
	W.O.G.	1440 PSI @ 100°F

PARTS LIST		
ITEM	DESCRIPTION	MATERIAL
1	BODY	CAST CHROME-MOLY (ASTM A 217, GRADE WC9)
2	SCREEN	STAINLESS STEEL (304)
3	GASKET	SPIRAL WOUND STAINLESS STEEL (304) – WITH GRAPHITE FILLER
4	CAP	CAST CHROME-MOLY (ASTM A 217, GRADE WC9)

Optional: Blow-off Plug, Stainless Steel (304)

Product Number†	SIZE	DIMENSIONS			WEIGHT
		A	B	E	
1/45THY-C9045P34-GT	1/4	2-15/16	2-7/16	1/4	3
3/85THY-C9045P34-GT	3/8	2-15/16	2-7/16	1/4	3
1/25THY-C9045P34-GT	1/2	2-15/16	2-7/16	1/4	3
3/45THY-C9045P34-GT	3/4	3-11/16	3	3/8	5
15THY-C9045P34-GT	1	4-9/16	4-5/16	3/8	6
11/45THY-C9045P34-GT	1-1/4	4-15/16	4-3/16	3/4	8
11/25THY-C9045P34-GT	1-1/2	5-9/16	4-11/16	3/4	10
25THY-C9045P34-GT	2	6-15/16	6-1/4	1	16
21/25THY-C9045P34-GT	2-1/2	12	9-3/8	1-1/4	43
35THY-C9045P34-GT	3	12	9-3/8	1-1/4	43

†See "Style SSB-7 Product Number Configuration" for additional options.

STANDARD SCREENS SUPPLIED

SIZE	SCREEN GAGE	SCREEN PERFORATION			
		FOR STEAM	OPEN AREA	FOR LIQUID	OPEN AREA
in		in		in	
1/4 to 3	26	3/64	33%	1/16	30%

Standard screens supplied are for **steam service**, unless otherwise specified.

Options: Other meshes, perforations, and screen materials are available.

KECKLEY

3400 CLEVELAND SKOKIE ILLINOIS

DRAWING NO.
AL 77015C9

DIMENSIONAL ASSEMBLY

PART NO.

1/4" to 3" 600# Threaded Style SB-7C9

SCALE: NTS

DATE: 07/01/2011

MAT'L: Cast Chrome-Moly WC9

REQ. ---

DR. BY DSF