

Style SD-C6 & SD-KC6

Basket Strainer, Threaded

Cast Chrome-Moly (ASTM A 217, Grade WC6)

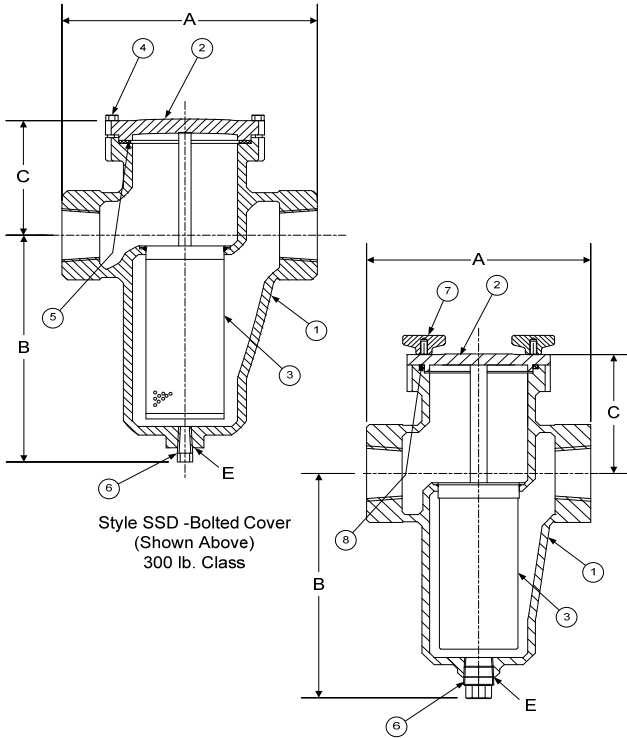

Style SSD - Bolted Cover
(Shown Above)
300 lb. Class

Style SSD-K - Knob Type Cover
(Shown Above)
Only Available in 150 lb. Class

PARTS LIST

ITEM	DESCRIPTION	MATERIAL
1†	BODY	CHROME-MOLY (ASTM A 217, GRADE WC6)
2	COVER	CHROME-MOLY (ASTM A 217, GRADE WC6)
3	BASKET	STAINLESS STEEL (304)
4	HEX HEAD CAP SCREW	STAINLESS STEEL
5	GASKET	SPIRAL WOUND STAINLESS STEEL (304)
6	PLUG	STAINLESS STEEL (316)
7*	KNOB	STAINLESS STEEL (ASTM A 351, GRADE CF8M)
8*	O-RING	VITON (MAX TEMPERATURE 350°F)

*Denotes parts for the Style SSD-K 150 lb. class only.

†Optional Body Materials Available in 304 and 400 Series SS, Alloy 20, Inconel, Hastelloy C276, and Stellite.

STANDARD SCREENS SUPPLIED

SIZE		SCREEN GAGE	SCREEN PERFORATION					
in	mm		FOR STEAM		FOR LIQUID		OPEN AREA	
			in	mm	AREA	in	mm	
3/8 to 2	10 to 50	28	1/32	.8	29%	1/16	1.6	30%
2-1/2 to 3	65 to 80	26	3/64	1.2	33%	1/16	1.6	30%

Standard screens supplied are for **liquid service**, unless otherwise specified.

Options: Other perforations, meshes, and screen materials are available.

SIZE		DIMENSIONS								WEIGHTS	
		A		B		C		E			
in	mm	in	mm	in	mm	in	mm	in	mm	lbs	kgs
3/8	10	4-9/16	116	4	102	3-1/8	79	3/8	10	6	3
1/2	15	4-9/16	116	4	102	3-1/8	79	3/8	10	6	3
3/4	20	4-9/16	116	4	102	3-1/8	79	3/8	10	6	3
1	25	5-5/16	135	4-7/8	124	3	76	3/8	10	9	4
1-1/4	32	6-5/16	160	6-1/2	165	4-1/8	105	1/2	15	14	6
1-1/2	40	6-5/16	160	6-1/2	165	4-1/8	105	1/2	15	14	6
2	50	8-1/4	210	7-7/8	200	4-3/4	121	3/4	20	27	12
2-1/2	65	9-5/8	245	8-3/4	222	4	102	1	25	34	15
3	80	11-1/4	286	11-3/8	289	5-7/8	149	1	25	60	27

Certified dimensional drawings are available upon request.

†This table reflects only the nearest metric equivalents.

FLOW COEFFICIENTS

Size	C _v	Size	C _v	Size	C _v
3/8"	19.9	1"	19.9	2"	55.7
1/2"	19.9	1-1/4"	35.4	2-1/2"	88.5
3/4"	19.9	1-1/2"	35.4	3"	123.3

TOTAL SCREEN AREA

Size	(in ²)	Size	(in ²)	Size	(in ²)
3/8"	11.72	1"	19.17	2"	64.36
1/2"	11.72	1-1/4"	41.65	2-1/2"	67.60
3/4"	11.72	1-1/2"	41.65	3"	128.17

*See DETERMINING RATIOS on page S5 of the Strainer Information Section for calculating NET FREE AREA of the screen to inside pipe area.

PRESSURE DROP CHART

Basket Strainers (Styles SD, SD-K, SSD, and SSD-K)

This pressure drop chart is based on the flow of clean water through the Keckley Strainer Styles listed above with screen perforations ranging from 3/64" through 1/8".

TO USE CHARTS:

Find your desired rate of flow (GPM) on the left hand side of the chart. Follow its corresponding horizontal line to the point where it intersects the diagonal line indicating the strainer pipe size. From this point of intersection, follow the vertical line down to the bottom of the chart to determine the approximate pressure drop.

CORRECTION FACTORS:

For finer mesh screens that are backed with a perforated sheet, multiply the pressure drops shown at right by the following:

- 40 mesh x 1.2
- 60 mesh x 1.4
- 80 mesh x 1.6
- 100 mesh x 1.7

