

DRAWING NO.

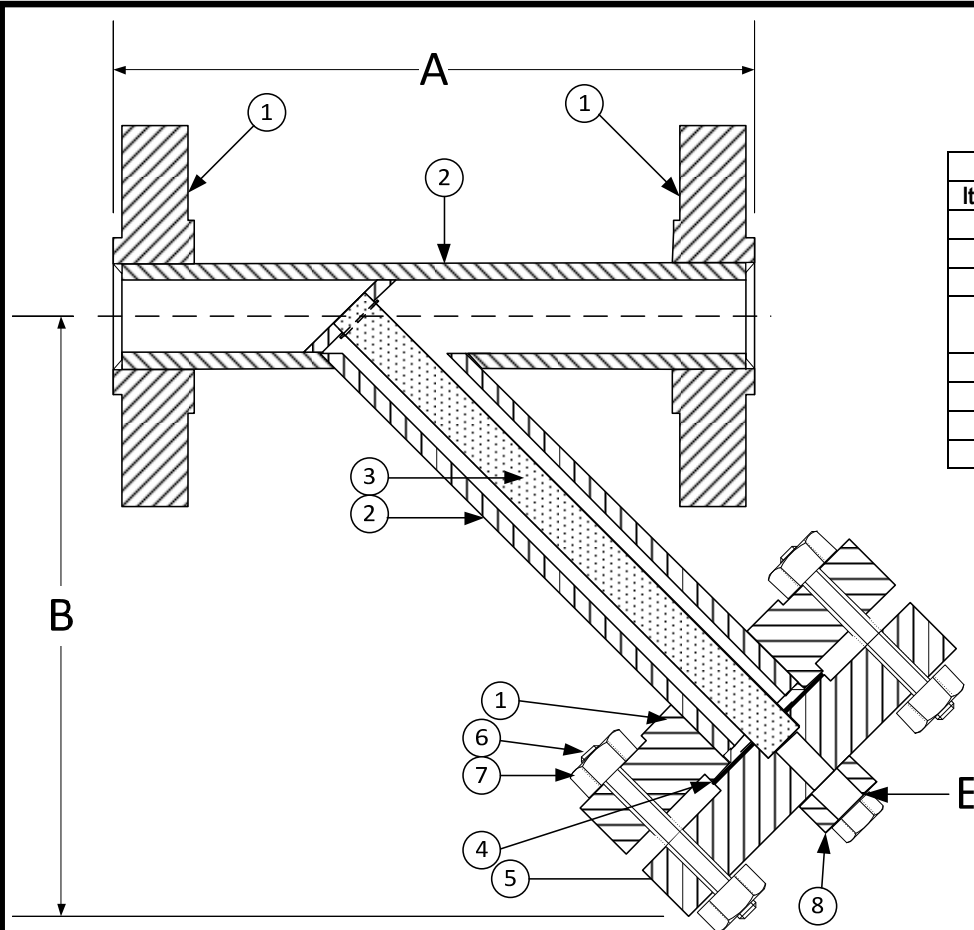

PARTS LIST		
Item	Description	Material
1	1500LB RFSO FLANGE	CARBON STEEL (ASTM A 105) B16.5
2	BODY	CARBON STEEL PIPE (ASTM A 53)
3	SCREEN	STAINLESS STEEL (304) - 1/8" PERFORATION
4	GASKET	SPIRAL WOUND STAINLESS STEEL (304) - WITH GRAPHITE FILLER
5	1500LB BLIND FLANGE (COVER)	CARBON STEEL (ASTM A 105) B16.5
6	STUDS	CARBON STEEL (ASTM A 193, GRADE B7)
7	NUTS	CARBON STEEL (ASTM A 194, GRADE 2H)
8	DRAIN - 6000# NPT HALF COUPLING W/ PLUG	CARBON STEEL (ASTM A 105)

Product Numbers†	SIZE	DIMENSIONS (in)			SCREEN REMOVAL (in)
		A	B	E	
27RFFY-FCS125P34-GBB	2	15-1/4	14	1	20-1/4
21/27RFFY-FCS125P34-GBB	2-1/2	17	15	1	21
37RFFY-FCS125P34-GBB	3	20-1/4	17	1	24-1/2
47RFFY-FCS125P34-GBB	4	22	20	1	28
57RFFY-FCS125P34-GBB	5	26	24	1	34
67RFFY-FCS125P34-GBB	6	28	26	1	37
87RFFY-FCS125P34-GBB	8	34	32	1-1/2	45
107RFFY-FCS125P34-GBB	10	40	34	1-1/2	48
127RFFY-FCS125P34-GBB	12	44	36	1-1/2	50
147RFFY-FCS125P34-GBB	14	50	38	2	53
167RFFY-FCS125P34-GBB	16	55	41	2	58
187RFFY-FCS125P34-GBB	18	60	45	2	63
207RFFY-FCS125P34-GBB	20	65	50	2	70
247RFFY-FCS125P34-GBB	24	75	55	2	77

†See "Style FSA Product Number Configuration" for additional options.

BODY PRESSURE & TEMPERATURE RATINGS - NON SHOCK	
NOM. RATING	2" to 24"
1500# RFSO	3705 PSI @ 100°F

 3400 CLEVELAND SKOKIE ILLINOIS		DRAWING NO.
		PART NO.
DIMENSIONAL ASSEMBLY		SCALE: NTS
1500lb. Flg. Style FSA		DATE: 05/29/2012
Fabricated Carbon Steel Y-Strainer		DR. BY DSF
MAT'L: Fabricated Carbon Steel	REQ. ---	