

DRAWING NO.

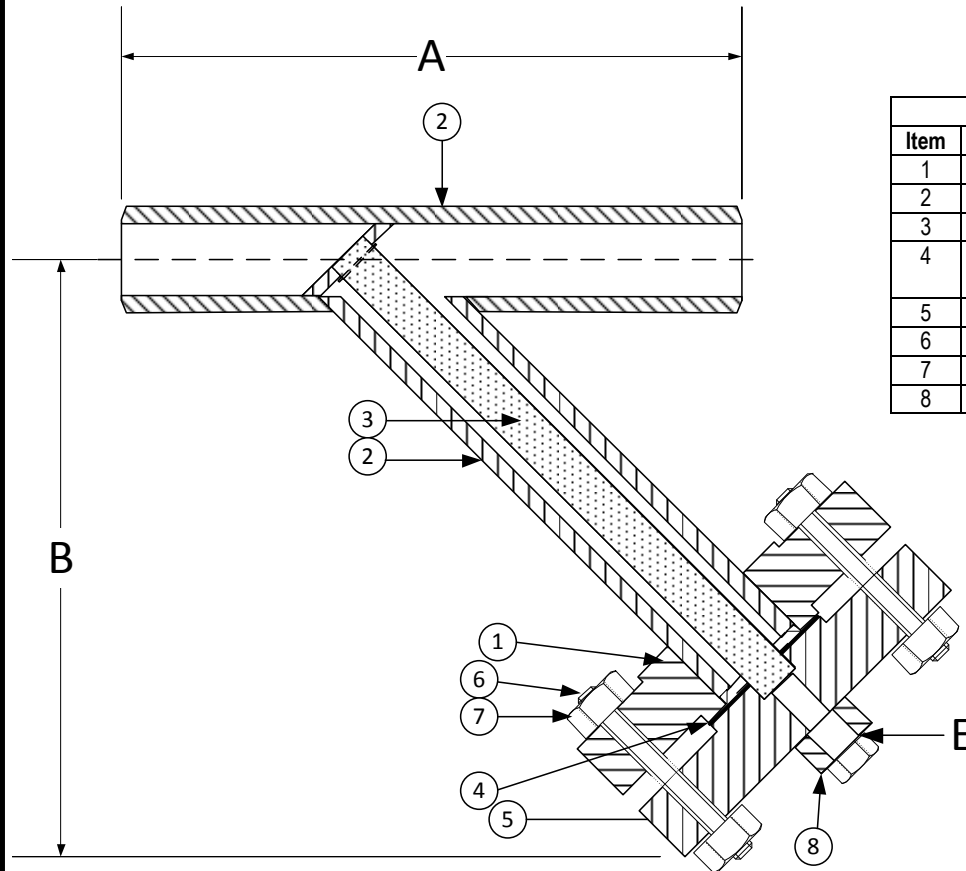

PARTS LIST		
Item	Description	Material
1	900LB RFSO FLANGE	STAINLESS STEEL (ASTM A 182, GRADE F-316) B16.5
2	BODY	STAINLESS STEEL (ASTM A 312, GRADE TP-316)
3	SCREEN	STAINLESS STEEL (304) – 1/8" PERFORATION
4	GASKET	SPIRAL WOUND STAINLESS STEEL (304) – WITH GRAPHITE FILLER
5	900LB BLIND FLANGE (COVER)	STAINLESS STEEL (ASTM A 182, GRADE F-316)
6	STUDS	STAINLESS STEEL (ASTM A 193, GRADE B8)
7	NUTS	STAINLESS STEEL (ASTM A 194, GRADE 8)
8	DRAIN – 6000# NPT HALF COUPLING W/ PLUG	STAINLESS STEEL (ASTM A 182, GRADE F-316)

Product Numbers†	SIZE	DIMENSIONS (in)			SCREEN REMOVAL (in)
		A	B	E	
26B2FY-F36125P34-GBB	2	15-1/4	14	1	20-1/4
21/26B2FY-F36125P34-GBB	2-1/2	17	15	1	21
36B2FY-F36125P34-GBB	3	20-1/4	17	1	24-1/2
46B2FY-F36125P34-GBB	4	22	20	1	28
56B2FY-F36125P34-GBB	5	26	24	1	34
66B2FY-F36125P34-GBB	6	28	26	1	37
86B2FY-F36125P34-GBB	8	34	32	1-1/2	45
106B2FY-F36125P34-GBB	10	40	34	1-1/2	48
126B2FY-F36125P34-GBB	12	44	36	1-1/2	50
146B2FY-F36125P34-GBB	14	50	38	2	53
166B2FY-F36125P34-GBB	16	55	41	2	58
186B2FY-F36125P34-GBB	18	60	45	2	63
206B2FY-F36125P34-GBB	20	65	50	2	70
246B2FY-F36125P34-GBB	24	75	55	2	77

†See "Style FSSA Product Number Configuration" for additional options.

BODY PRESSURE & TEMPERATURE RATINGS – NON SHOCK	
NOM. RATING	2" to 24"
900#	2160 PSI @ 100°F

 3400 CLEVELAND SKOKIE ILLINOIS		DRAWING NO.
		PART NO.
DIMENSIONAL ASSEMBLY		SCALE: NTS
900lb. Schd. 120 Butt Weld Style FSA		DATE: 05/29/2012
Fabricated 316 SS Y-Strainer		DR. BY DSF
MAT'L: Fabricated 316 SS	REQ. ---	