

DRAWING NO.
AL 88600

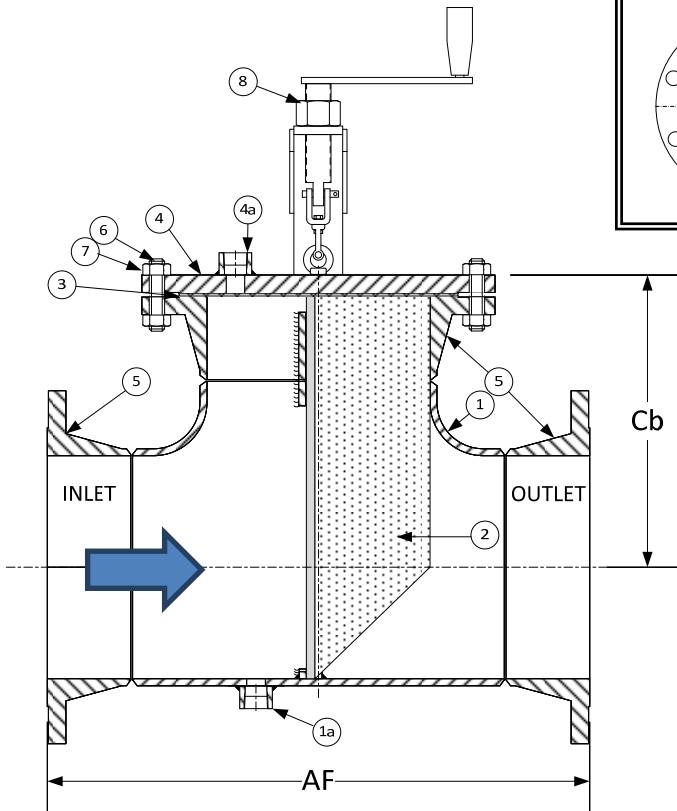
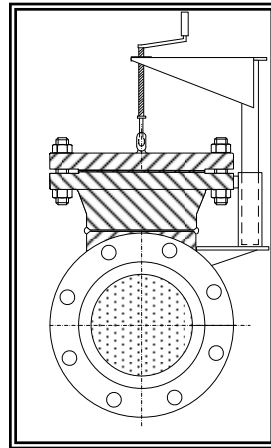

PARTS LIST		
ITEM	DESCRIPTION	MATERIAL
1	BODY	STAINLESS STEEL (ASTM A 403, CLASS WP-304)
1a	COUPLING - HALF, 6000# NPT	STAINLESS STEEL (ASTM A 182, GRADE F-304)
2	BASKET	STAINLESS STEEL (304) - 1/8" PERFORATION
3	GASKET	SPIRAL WOUND STAINLESS STEEL (304) - GRAPHITE FILLED
4	600LB RF BLIND FLANGE	STAINLESS STEEL (ASTM A 182, GRADE F-304)
4a	COUPLING - HALF, 6000# NPT	STAINLESS STEEL (ASTM A 182, GRADE F-304)
5	600LB RFWN FLANGE	STAINLESS STEEL (ASTM A 182, GRADE F-304) B 16.5
6	STUDS	ALLOY STEEL (ASTM A 193, GRADE B7)
7	NUTS	ALLOY STEEL (ASTM A 194, GRADE 2H)
8	LIFTING DAVIT COMPONENTS	STAINLESS STEEL (ASTM A 312 & ASTM A 240)

Product Numbers [†]	DIMENSIONS (in)					WEIGHT (lbs)	
	SIZE	AF	Cb	Vent	Drain	Cover	Total
25RFFT-F34125P34-GDB	2"	11-1/4	6-7/8	1/8	1/2	10	50
21/25RFFT-F34125P34-GDB	2-1/2"	12-3/4	7-3/4	1/8	1/2	15	75
35RFFT-F34125P34-GDB	3"	13-3/4	8-3/8	1/8	3/4	20	97
45RFFT-F34125P34-GDB	4"	16-3/4	10-1/8	1/2	3/4	41	177
55RFFT-F34125P34-GDB	5"	19-1/4	11-5/8	1/2	1	68	285
65RFFT-F34125P34-GDB	6"	21	12-5/8	1/2	2	86	350
85RFFT-F34125P34-GDB	8"	25	15	1/2	2	140	577
105RFFT-F34125P34-GDB	10"	30	17-1/2	1/2	2	231	921
125RFFT-F34125P34-GDB	12"	32-3/4	19-1/4	1/2	2	295	1148
145RFFT-F34125P34-GDB	14"	35-1/2	20-3/4	1/2	2	378	1716
165RFFT-F34125P34-GDB	16"	38-1/2	22-1/2	1/2	2	527	2325
185RFFT-F34125P34-GDB	18"	42	24-1/2	1/2	2	665	2772
205RFFT-F34125P34-GDB	20"	45-1/2	26-1/2	1/2	2	855	3478
245RFFT-F34125P34-GDB	24"	50-1/2	29-1/2	1/2	2	1250	4963

[†]See "Style T Product Number Configuration" for additional options.

BODY PRESSURE & TEMPERATURE RATINGS - NON SHOCK	
NOM. RATING	2" to 24"
600# RFWN	1440 PSI @ 100°F

 3400 CLEVELAND SKOKIE ILLINOIS	DRAWING NO. AL 88600
	PART NO.
DIMENSIONAL ASSEMBLY	SCALE: NTS
600lb. Flg, Style TD, Fabricated 304ss Tee Strainer	DATE: 04/03/2017
MAT'L: (As Noted Above)	DR. BY DSF
REQ. ---	