

DRAWING NO.
AL 95220

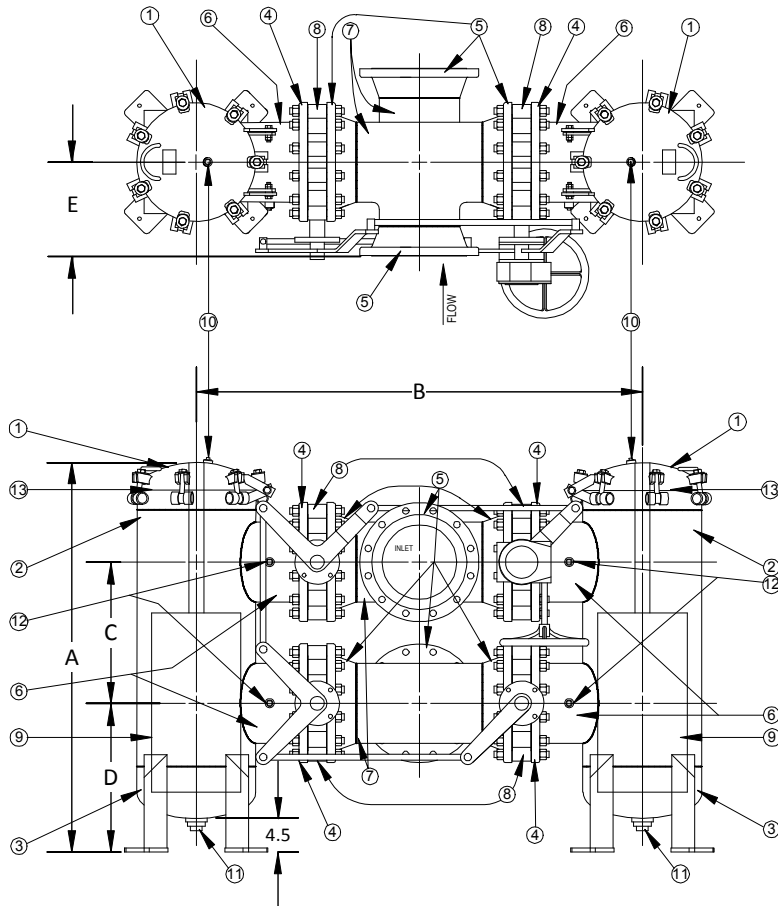

BODY PRESSURE & TEMPERATURE RATINGS – NON SHOCK											
NOM. RATING	Up to 450°F										
	4"	5"	6"	8"	10"	12"	14"	16"	18"	20"	24"
300# RFSO	390	390	365	380	380	365	345	305	305	235	235

Pressure limitations due to quick open cover design.

Product Number†	DIMENSIONS (in)								
	SIZE	A	B	C	D	E	Vent	Drain	Weight (lbs)
44RFFD-F36125P34-BOQB	4	42	35	13	14	7-1/2	1/2	3/4	764
54RFFD-F36125P34-BOQB	5	44	37	14	14	8-3/4	1/2	1	938
64RFFD-F36125P34-BOQB	6	48	43	16	15	9-1/2	1/2	2	1227
84RFFD-F36125P34-BOQB	8	54	49	18	17	11-3/8	1/2	2	1807
104RFFD-F36125P34-BOQB	10	62	63	21	20	13-1/8	1/2	2	2681
124RFFD-F36125P34-BOQB	12	72	71	25	24	15-1/8	1/2	2	3893
144RFFD-F36125P34-BOQB	14	75	77	26	24	16-5/8	1/2	2	5260
164RFFD-F36125P34-BOQB	16	83	84	29	27	17-3/4	1/2	2	7070
184RFFD-F36125P34-BOQB	18	87	89	31	27	19-3/4	1/2	2	8678
204RFFD-F36125P34-BOQB	20	93	94	34	28	21-3/8	1/2	2	10547
244RFFD-F36125P34-BOQB	24	111	104	39	30	23-5/8	1/2	2	14485

†See "Style FD Product Number Configuration" for additional options.

PARTS LIST

Item	Description	Material
1	300lb. T-Bolt Cover	Stainless Steel (ASTM A 240, Grade 316)
2	Standard Weight Pipe	Stainless Steel (ASTM A 312, Grade TP-316)
3	Standard Weight End Cap	Stainless Steel (ASTM A 403, Grade WP-316)
4	300lb. Slip-On Flange	Stainless Steel (ASTM A 182, Grade F-316)
5	300lb. Weld-Neck Flange	Stainless Steel (ASTM A 182, Grade F-316)
6	Standard Weight Pipe	Stainless Steel (ASTM A 312, Grade TP-316)
7	Standard Weight Tee	Stainless Steel (ASTM A 403, Grade WP-316)
8	Butterfly Valves	Cast Iron Body / Stainless Steel (316) Discs – Buna-n Seats / Single Gear Operator
9	Baskets	Stainless Steel (304) – 1/8" Perforations
10	Air Vent	3000# NPT SS Half Coupling (ASTM A 182, Grade 316)
11	Drain Connection	3000# NPT SS Half Coupling (ASTM A 182, Grade 316)
12	Differential Pressure Taps	3000# NPT SS Half Coupling (ASTM A 182, Grade 316)
13	O-Ring	Buna-n

*Buna-n o-ring good for temperatures up to 250°F. For higher temperatures, consult Factory.

 3400 CLEVELAND SKOKIE ILLINOIS	DRAWING NO. AL 95220
	PART NO.
DIMENSIONAL ASSEMBLY	SCALE: NTS
300Lb. Flange Style FSSDPXF Fabricated Duplex Basket Strainer	DATE: 07/01/2011
MAT'L: Fabricated (316ss) REQ. ---	DR. BY DSF