

DRAWING NO.
AL 95240

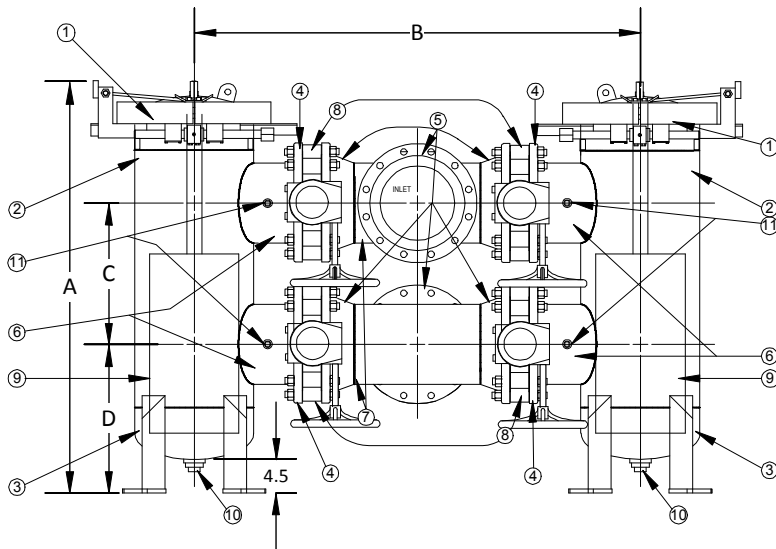
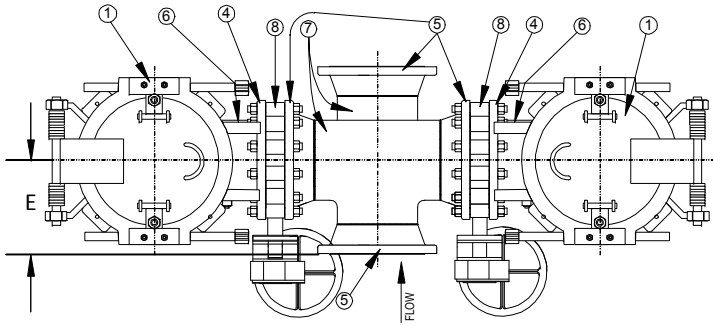

BODY PRESSURE & TEMPERATURE RATINGS – NON SHOCK

NOM. RATING	8" to 24"
600# RFWN	1440 PSI @ 100°F

Product Number†	DIMENSIONS (in)								
	SIZE	A	B	C	D	E	Vent	Drain	Weight (lbs)
85RFFD-F36125P34-BOQB	8	61	55	20	17	12-1/2	1/2	2	2996
105RFFD-F36125P34-BOQB	10	70	70	23	20	15	1/2	2	5142
125RFFD-F36125P34-BOQB	12	80	77	26	24	16-3/8	1/2	2	7320
145RFFD-F36125P34-BOQB	14	87	82	27	24	17-3/4	1/2	2	9576
165RFFD-F36125P34-BOQB	16	96	91	30	27	19-1/4	1/2	2	14161
185RFFD-F36125P34-BOQB	18	100	96	33	27	21	1/2	2	16792
205RFFD-F36125P34-BOQB	20	106	101	35	28	22-3/4	1/2	2	23650
245RFFD-F36125P34-BOQB	24	124	111	40	30	25-1/4	1/2	2	29257

†See "Style FD Product Number Configuration" for additional options.

PARTS LIST

Item	Description	Material
1	600lb. Double Bolt Cover	Stainless Steel (ASTM A 240, Grade 316)
2	Standard Weight Pipe	Stainless Steel (ASTM A 312, Grade TP-316)
3	Standard Weight End Cap	Stainless Steel (ASTM A 403, Grade WP-316)
4	600lb. Slip-On Flange	Stainless Steel (ASTM A 182, Grade F-316)
5	600lb. Weld-Neck Flange	Stainless Steel (ASTM A 182, Grade F-316)
6	Standard Weight Pipe	Stainless Steel (ASTM A 312, Grade TP-316)
7	Standard Weight Tee	Stainless Steel (ASTM A 403, Grade WP-316)
8	Butterfly Valves	Cast Iron Body / Stainless Steel (316) Discs – Buna-n Seats / Single Gear Operator
9	Baskets	Stainless Steel (304) – 1/8" Perforations
10	Drain Connection	3000# NPT SS Half Coupling (ASTM A 182, Grade 316)
11	Differential Pressure Taps	3000# NPT SS Half Coupling (ASTM A 182, Grade 316)

*Buna-n o-ring good for temperatures up to 250°F. For higher temperatures, consult Factory.

 3400 CLEVELAND SKOKIE ILLINOIS	DRAWING NO. AL 95240
	PART NO.
DIMENSIONAL ASSEMBLY	SCALE: NTS
600Lb. Flange Style FSSDPXF Fabricated Duplex Basket Strainer	DATE: 07/01/2011
MAT'L: Fabricated (316ss) REQ. ---	DR. BY DSF